

MATERIAL:
 BUSHING: Stainless Steel.
 BASE: PBT(UL 94-V0) , PC(UL 94-V2)
 ACTUATOR: PC ; Stainless Steel.
 INNER ASSEMBLY: POM/PA66.
 SPRING: Spring steel.
 SEALING: Silicone.
 O-Ring: Silicone.
 TERMINAL: Brass, Silver plated.
 HEX NUT: Nickel plated brass.
 RoHS

本公司智慧財產，未經同意不得複製
 DAILYWELL copyright, may not be used
 without permission from DAILYWELL

MPB19-XXXXXR-XX-JX

Body type

A0	Stainless (Natural)
B1	Brass (Mirror Chrome Plated)
B2	Brass (Nikel Plated)
C3	Al alloy (Black Anodized)

Button type

F	Flat
---	------

Contact Configuration

1	1NO 1NC
2	2NO 2NC

Operating type

0	Momentary
1	LOCK

LED color

0	Without LED
A	Red/Green
B	Red/Blue
D	Blue/Yellow
G	Red/Yellow
H	Green/Yellow

LED voltage

0	Without Resistor
3	3V DC
6	6V DC
12	12V DC
24	24V DC
36	36V DC
110	110V DC
220	220V DC

Terminal plating

Q	Silver
R	Gold

Light type

0	Without LED
R	Ring (Fixed)
D	Spot
E	Ring (Moveable)

Terminal shape

J	Solder Terminal
---	-----------------

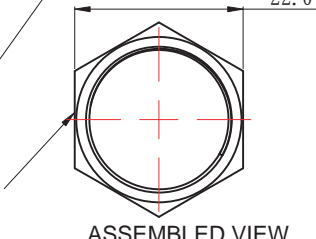
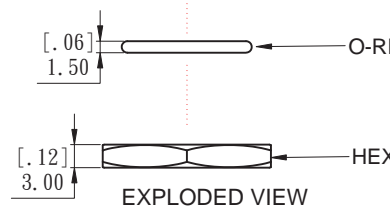
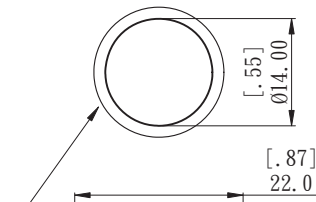
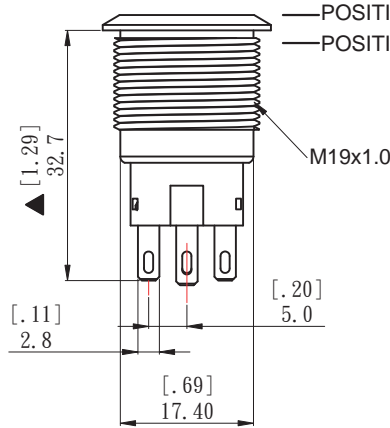
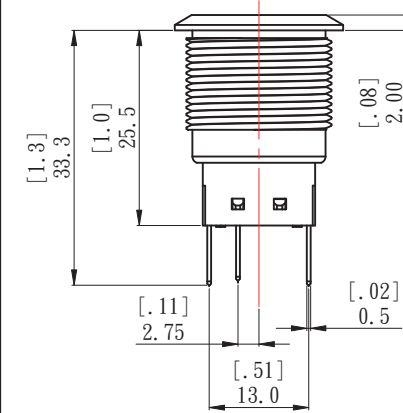
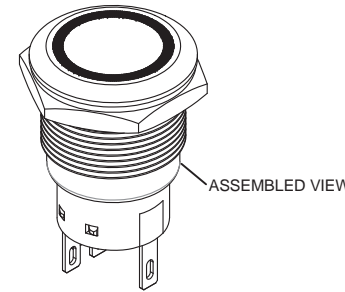
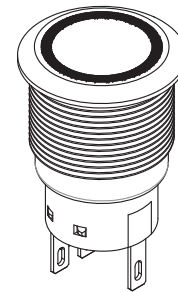
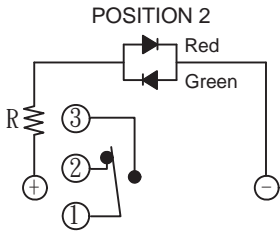
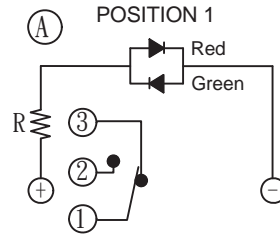
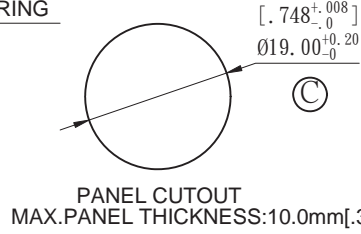
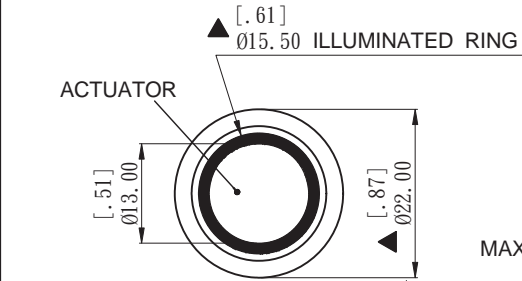

SPECIFICATIONS

- CONTACT MATERIAL: Brass, coin silver, silver plated.
- RATING: 1th 5A/250VAC. resistive load 3A/250VAC.
- ELECTRICAL LIFE: 50,000 MAKE-AND-BREAK CYCLES AT FULL LOAD.
- MECHANICAL LIFE: Momentary 1,000,000.
- INSULATION RESISTANCE: 1,000MΩ MIN AT 500VDC .
- DIELECTRIC STRENGTH: 2,000V RMS@sea level.
- CONTACT RESISTANCE: 50mΩ MAX. @1A 12VDC(initial value).
- OPERATING TEMPERATURE: -20°C to 55°C .
- TRAVEL: ABOUT 3.2mm.
- OPERATION PRESSURE: 1Pole 2.5±1N. / 2Pole 3.5±1N.
- INGRESS PROTECTION: IP67,IK10(Stainless).
- TORQUE: 5~14Nm.

德利威電子股份有限公司
 DAILYWELL ELECTRONICS CO.,LTD.

符號	原尺寸	修改後尺寸	變更日期
1 (A)		CIRCUIT修正	SEP-20-2017
2 (B)		修正端子跳板材質說明	APR-30-2020
3 (C)		開孔尺寸調整19.00並加註公差	AUG-17-2020
4 (D)			
5 (E)			

SCALE (比例) : 1:1
 TOLERANCE (公差) :
 0.00mm±0.25mm
 0.0mm±0.40mm
 ANGULAR: ±2°
 FILE NAME : MPB19-0732

TITLE 圖名	METAL PUSHBUTTON SWITCH		SIZE 圖紙	A4
DWG NO. 圖號	MPB19-A0F10R-A12-JQ		UNIT 單位	inch mm
REV. 版本	D	DATE 日期	JAN - 23 - 2017	SHEET 張數
APPROVE 審核	顧睿豐	CHECK 確認	范德雯	DRAW 製圖
			IRENE	1 of 1