

■ **Specifications**

Current rating:3.0A AC/DC
Voltage rating:250V AC/DC
Contact resistance:20m ohm. max.
Insulation resistance:1000M ohm. Min.
Withstanding voltage:600V AC for one minute
Operating temperature range:-40°C to +105°C

■ **Material and Finish**

Insulator:High Temp. Plastic(UL94V-0)
Contact:Copper Alloy
Plating:Gold Plated

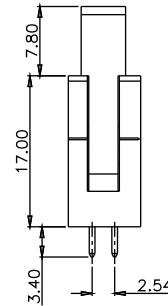
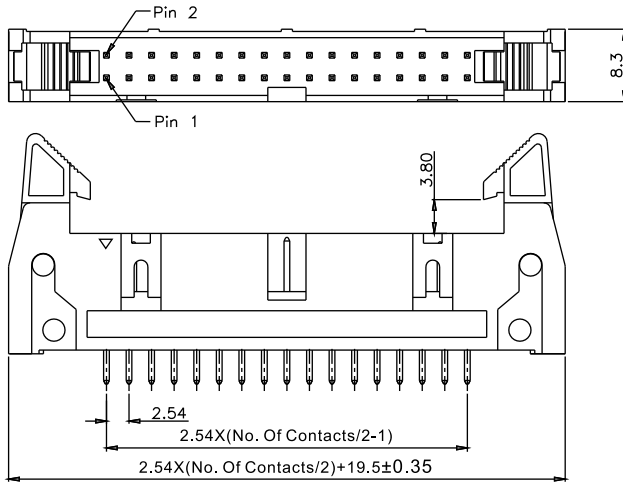

P/N:2216S-XXG-01

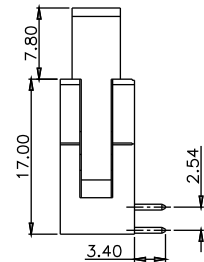

P/N:2216R-XXG-01

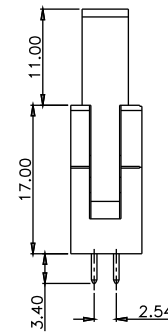
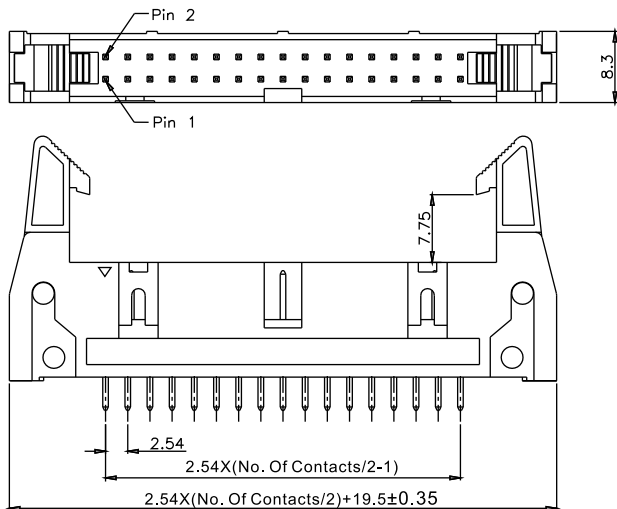

P/N:2216S-XXG-02

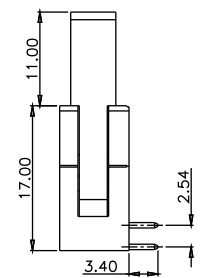

P/N:2216R-XXG-02

■ **Ordering Information**

2216S-XXG-01

① ② ③ ④

① S: Straight Type R: Right Angle Type	② No. Of Contacts ③ G: Gold Plated	④ 01: Short ejector 02: Long ejector
---	---------------------------------------	---

■ **Recommended PCB Layout**

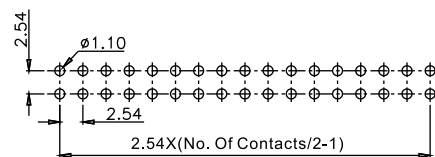

Unit:mm